

CONTOIL[®] DN15 - 50

VZF II / VZFA II

Table of content

1	Safety	3
2	Scope of supply and accessories	7
3	Installation	8
4	Operation	17
5	Maintenance and Repair	29
6	Troubleshooting	32
7	Decommissioning, Dismantling and Disposal	35
8	Technical Data	36
9	Appendix	47

1 Safety







1.1 Intended Use

The CONTOIL[®] flow meter is designed and solely intended for the flow measurement of Diesel oil to Heavy Fuel Oil according to ISO 8217-2010

Improper or non-intended use may lead to the operational reliability of the device and is no longer guaranteed. The manufacturer accepts no liability for any resulting damage to human and material.

1.2 Notes on safety rules and symbols

The devices are designed to meet the latest safety requirements. They were tested and delivered in a condition that ensures safe operation. Improper or non-intended use of the devices, can however, be dangerous. Therefore pay particular attention to the safety instructions within this manual always shown by the following symbols:

	WARNING WARNING indicates a hazardous situation which, if not avoided, could result in death or serious injury.
	CAUTION CAUTION indicates a hazardous situation which, if not avoided, could result in minor or moderate injury.
	NOTICE NOTICE indicates a hazardous situation which, if not avoided, could result in property damage.
	NOTE NOTE indicates helpful tips and recommendations, as well as information for efficient and trouble-free operation.
	See doc VDxxxx, page ## or See section XX on page ## or WEB link to QR code
	

1.3 Safety rules and precautionary measures

The manufacturer accepts no responsibility if the following safety rules and precautions are disregarded.

- Modifications of the device implemented without preceding written consent from the manufacturer, will result in the immediate termination of product liability and warranty period.
- Installation, operation, maintenance and decommissioning of this device must be carried out by trained, qualified specialists, authorized by the manufacturer, operator or owner of the facility. The specialist must have read and understood these Installation and Operating Instructions and must follow the instructions here in.
- Check the voltage and the information on the type plate before installing the device
- Check all connections, settings and technical specifications of peripherals which may be present.
- Open the housing or parts of housings, which electric or electronic components included, only when the electric power is turned off.
- Do not touch any electronic components (ESD sensitivity).
- Expose the system with respect to the mechanical load (pressure, temperature, IP protection, etc.), only to a maximum of the specified classifications.
During operations that involve mechanical components of the system, release the pressure in the pipe system or reduce the temperature of the medium to a safe level for humans
- None of the information stated here or elsewhere releases planners, installers and operators from their own careful and comprehensive assessment of the respective system configuration in terms of functional capability and operational safety
- **The local labor, safety laws and regulations must be adhered to.**

1.4 About the operation manual

The manufacturer reserves the right to make changes to technical data without notice. The latest information and versions of these operating instructions, can be requested at your local dealer.

WARNING



The manufacturer accepts no responsibility if the instructions and procedures as described in this manual are not followed!

NOTICE



This installation guide is intended for qualified personnel and therefore does not include basic working steps.
Before operating the equipment or system, this Installation and Operating Instructions must be completely read and understood.

Keep these instructions for later look up!

1.5 Handling, Transport and Storage

We congratulate you on purchasing this high-quality instrument. Please check all components and parts delivered promptly after the receipt of goods.

1.6 Return of materials

- Never send a device/system back if you are not absolutely certain that all traces of hazardous substances have been removed, e.g. substances which have penetrated crevices or diffused through plastic.
- Costs incurred for waste disposal and injury (burns, etc.) due to inadequate declaration and/or cleaning will be charged to the delivering company or the operator.

For a device that is sent back to Aquametro for repair or calibration the following points are an absolute must:

- Always quote type and serial number when contacting an Aquametro AG office or a Aquametro representative.
- Always enclose a duly completed "Declaration of decontamination" form (FO0451e).
- Only in special cases (e.g. for the reconstruction of causes of errors) and only with the prior consent of the Aquametro AG, equipment must be returned in the unpurified state. In this case also the contact person at Aquametro AG, which has granted the approval to return a crude device must be stated.

Only then Aquametro AG can transport, examine and repair a returned device.



Use form FO0451e.

2 Scope of supply and accessories

2.1 General

- 1 Flow meter with electronic display unit.
- 1 mounting and operating instruction (this manual)

2.2 Flow meter configuration

The CONTOIL[®] flow meters consist of a hydraulic part, a coupling with temperature sensor included and an electronic display unit.

The hydraulic part determines the nominal size of the flow meter.

The flow meters are calibrated before they leave the factory. Nevertheless, for optimal results of differential measurement, flow meters of VZFA II with either a pairing or a special linearized calibration should be used.

Electronic display unit VZF II / VZFA II

local electronic display unit with 2 pulse output and 1 passive analog current loop

**Display unit
with coupling and
temperature sensor**

Hydraulics

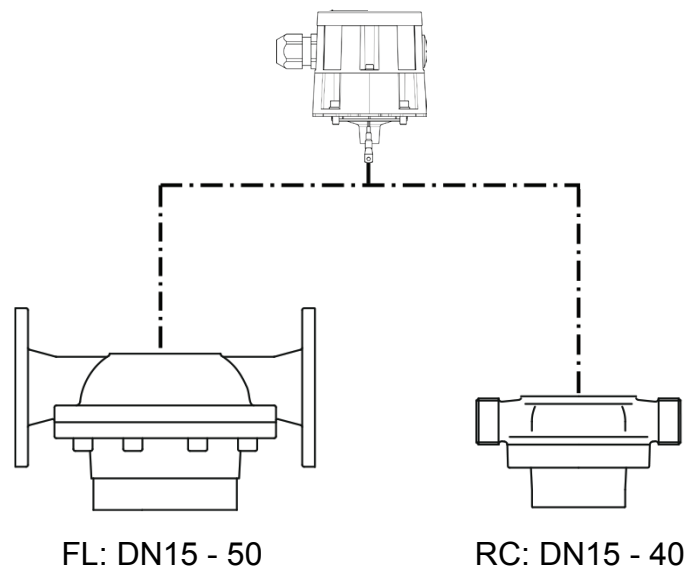

For details, see dimensional drawings in
Technical Data on page 42.

3 Installation

CAUTION

The surfaces of the device/system and the medium may be hot.



Risk of burns!

- Carry out work only on cooled devices/systems.
- Work may only be performed by authorized specialists in accordance with the applicable regulations.
- Use appropriate protective equipment.

WARNING

The device/system may be under pressure.



Risk of severe injury!

- Carry out work only on non-pressurized systems.
- When working on the device/system watch out for leaking medium.
- Work may only be performed by authorized specialists in accordance with the applicable regulations.
- Use appropriate protective equipment, particularly safety goggles

3.1 Mounting

Flow meter installation

Identify the flowmeter and ensure that the flowmeter is suitable for the intended process and conditions. Easy access for reading the flow meter and controlling the ancillary equipment is important. Provided that the **arrow on the housing is in the direction of flow**, the flow meter can be installed in any position without any special modifications. The electronic display unit is rotateable in 90° steps to the installed position.

Exception: upside down installation.

Flow conditioners are unnecessary.

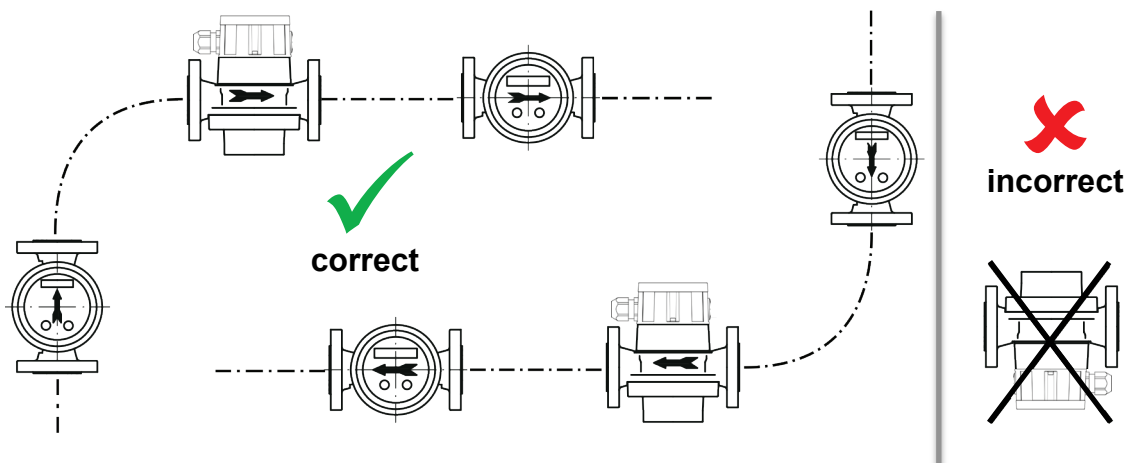

NOTE



The layout of piping must ensure that the flow meter is filled with liquid at all times and that no inclusions of air, foam or gas may occur.

Aquametro AG recommends to install bypass valves.

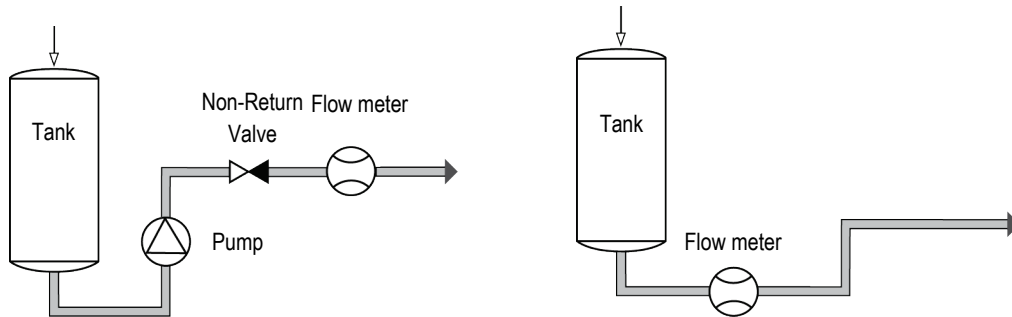

The quantities from all consumers must be registered by the flow meter.

Correct layout of flow meter and accessories

If the flow meter is used for viscosities higher than 5 mPa.s, or if it is mounted on the suction side of a pump, the pressure loss and the flow rate that can still be attained should be determined with the help of the pressure loss curves provided in CONTOIL® Technical Information. In addition, the pressure loss due to installed filters must be taken into consideration.

Select the flow meter and ancillaries according to the working conditions listed below:

- Flow rate (maximum expected application flow rate = maximum continuous flow rate of flow meter Q_{cont})
- Material compatibility with medium
- Operating pressure and temperature
- Ambient temperature

- The flow meters must be selected according to the max. flow rate and not according to the pipe diameter. If necessary, adapt the pipework.

Non-Return-Valves

In order to avoid backflow and draining, Non-Return-Valves must be mounted after the flow meter. Backflow and draining can cause faulty measurements and may damage the flow meter.

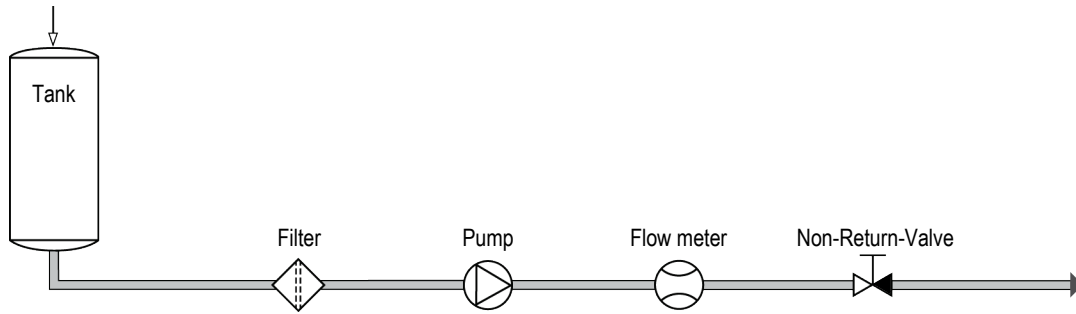

Pulsations at the flow meter shall be avoided to ensure a trouble free operation of the instrument.

Dirt filter, Safety filter

Filters should be fitted to prevent any damage to the flow meter from impurities in the oil.

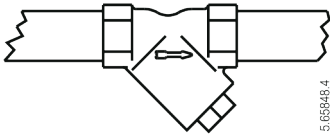

Maximum mesh width for filters		
Nominal size	Flow meter type	
	VZF II	VZFA II
DN15	0.250mm	0.100mm
DN20	0.400mm	0.100mm
DN25	0.400mm	0.250mm
DN40	0.600mm	0.250mm
DN50	0.600mm	0.250mm

NOTICE



The filter mounted in the flow meter inlet is only a safety filter and can not act as a dirt filter.

Risk of malfunction or damage.

- If the medium contains dirt always have a dirt filter installed upstream of the flow meter .

Heat insulation

The electronic counter must not be insulated. This could cause its permitted temperature range to be exceeded.

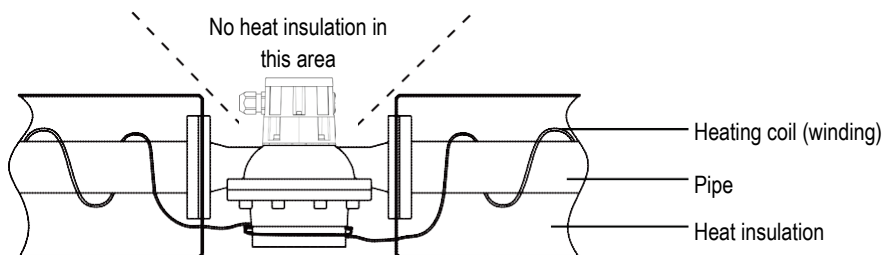

The permitted temperature ranges for the flow meter must be observed.

Special requirements - differential measurements

For differential measurements, one flow meter is installed in the supply pipeline and one in the return pipeline. The flow difference between these meters determines the consumption.

If ordered with the "differential measurement" option, VZFA II flow meters are calibrated in accordance with the indicated supply and return flow volumes. The flow meters are labeled "SUPPLY" and "RETURN". Make sure that these flow meters are installed in the correct pipeline, i.e. the supply flow meter shall be installed in the supply pipeline and the return flow meter shall be installed in the return pipeline.

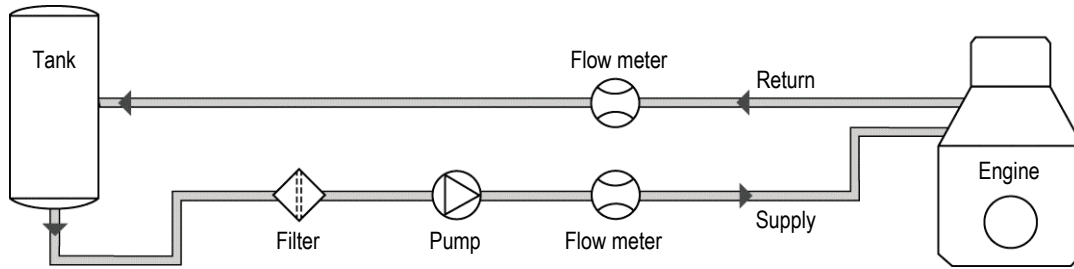

Special requirements - ships

On ships, attention is required to ensure that the engine can continue to operate at full power even if there is heavy filter contamination or if the flow meter requires maintenance. A pressure switch can be used to switch over to the bypass and to draw attention for servicing. The engine then continues to operate but without consumption measurements.

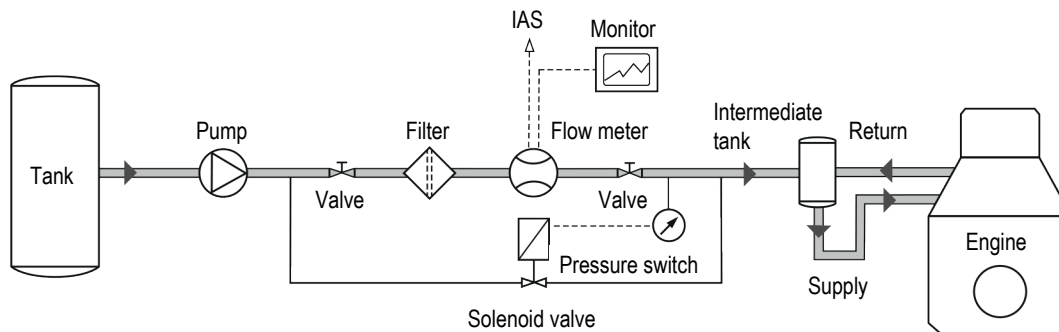
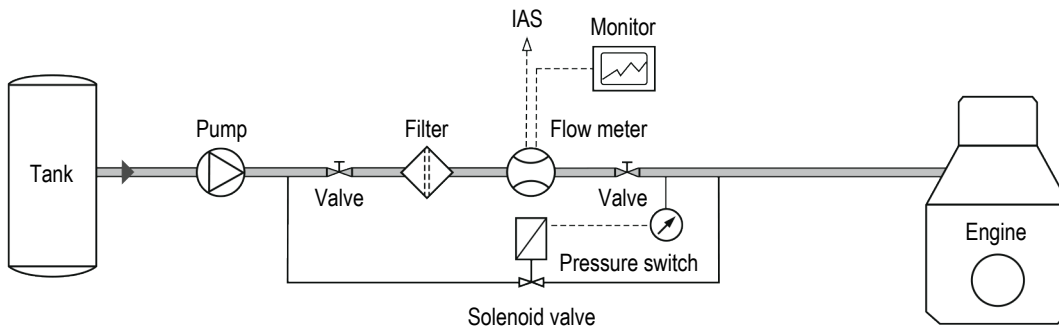

Ship classification societies require the installation of bypass pipes. The relevant regulations must be followed.

Installation of the flow meter on the suction side of a pump

If the flow meter is installed on the suction side of a pump, consideration must be given to avoid air-intake or foam.

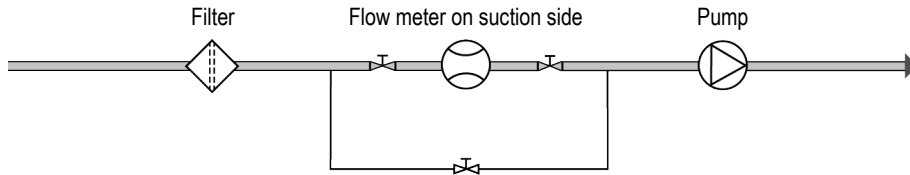

Installation of the flow meter on the pressure side of a pump

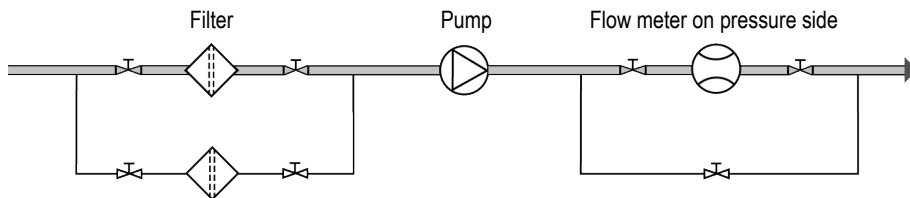

Special requirements - filling and dosing units

For filling and dosing, the valve must be fitted between flow meter and discharge. The shorter the pipe section between valve and discharge, the higher the accuracy. Avoid water hammer if fast closing valve is installed.

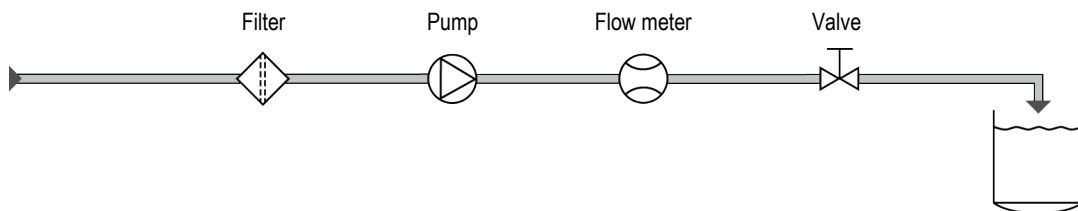

Flushing of pipes

If the pipes are to be flushed at a later stage, stop valves shall be provided on both sides of the flow meter.

NOTICE



Accumulation of debris will occur in front of the stop-valve during flushing. To eliminate this, replaced the flow meter with a spool piece.

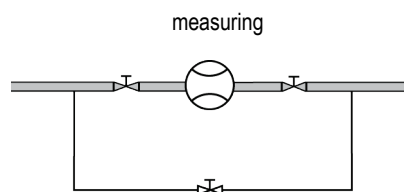
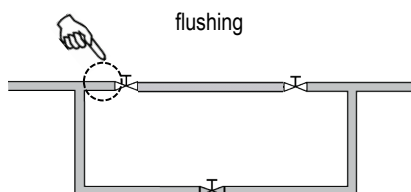

3.2 Mechanical installation

WARNING

Leakage or rupture due to connections being made using force.



Risk of severe injury!

Risk of substantial property damage!

- Never attempt to overcome misalignments (lateral, angular, longitudinal, torsional) using force.
- Make sure the pipings are flexible enough, if not: use compensators.
- Consider the effects of thermal contraction and expansion.

WARNING

Leakage or rupture due to misuse of the mounting material.



Risk of severe injury!

Risk of substantial property damage!

- Regarding mechanical strength, with bolts, screws and nuts, use the prescribed dimensions.
- Use the full number of bolts, screws and nuts.
- Observe the prescribed thread lubrication (grease or dry!).
- Tighten the bolts and nuts in the proper sequence to the specified torque.

If using flanged connections, the correct number of bolts must be fitted and they must be tightened with the correct torque in accordance with the screw manufacturer's instructions. Make sure that no hazardous fumes can build up in the piping and in the flow meter during commissioning, decommissioning and dismantling. The flow meter must at all times during operation be completely filled with liquid. Check the flow meter periodically for tightness of the connections and for proper functioning. If work is to be done on the installation, before each intervention: release the pressure in the installation if hazardous liquids are used, wear protective clothing and safety goggles, place a collecting tray underneath the installation.

Preparing for installation

Check flow meters and installation material.

Compare the data of the flow meter name plate with the expected maximum conditions of the installation. They may not exceed the flow meter specifications:

- Maximum continuous flow rate (Qcont l/h)
- Maximum operating pressure (PN bar)
- Maximum temperature (°C)
- Appropriate connections(threaded, or flanged) and seals (gaskets)
- Fasteners for the flow meter
- Resistance to liquid to be metered and temperature

CAUTION

Unauthorized start-up while mounting.



Risk of injury!

- Make sure that unauthorized start-up is not possible while mounting.
- Comply with the applicable working regulations during all work on the system.

NOTE



When existing systems are altered:
Take the flow meter out of operation in order to flush the system clean of debris. Flushing information on page 12.

Trial operation

Start trial operation (without flow meter); open the stop valves **slowly** when doing this.

- Carry out a pressure test in the plant
- Check for leaks and tightness of all bolts
- Flush the pipework until clean (flow meter out of pipeline)
- Release the pressure and stop the system again

This trial operation ensures that all pipework is tight, clean and free of foreign matter that could damage the flow meter.

Installing the meter in the pipe

Remove the **protection plugs or caps** from the flow meter (inlet and outlet).

Insert the flow meter into the pipeline in the prescribed position and flow direction. The arrow on the flow meter should correspond with the direction of flow. Install mating flanges parallel and without tension in the pipe.

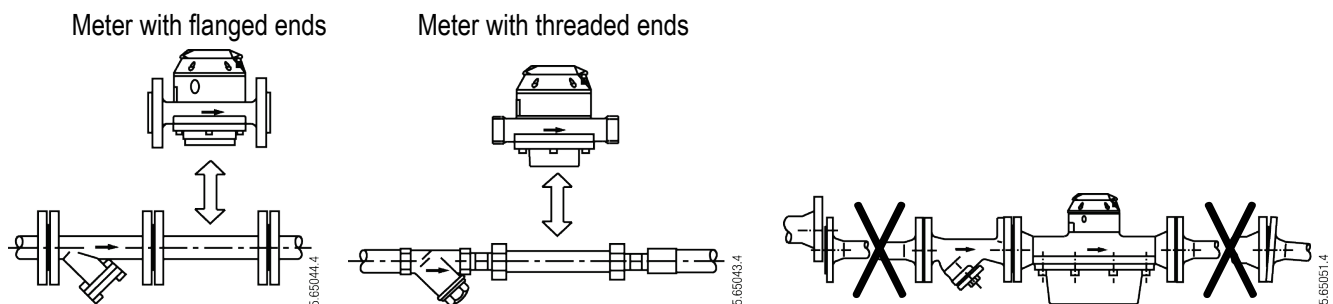

For pipes made of copper or thin-walled steel, the flow meter requires additional supports. Use appropriate fasteners.

3.3 Electrical Installation

NOTICE



Electrical connection to power supply and other systems.

Risk of malfunction or damage

- Review of technical data, chapter 8.1

3.4 Electrical connection VZF II / VZFA II

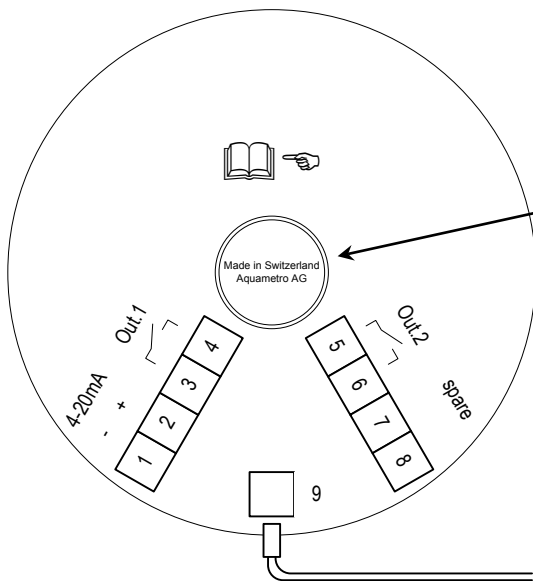

Sensor area! (Sensor dome)

No cables, wires or other installation material must be present in this area. This can lead to incorrect measurements and damage to the meter.

Solid state relay (out1 & out2)

$R_{ON} \leq 100\Omega$, $R_{OFF} \geq 10M\Omega$

$U_{max} \leq 48VAC/VDC$, $I_{max} \leq 50mA$

 Pt1000 RTD

NOTE



Wire size for terminal 1–6 is: 0.75...1.5mm² / 20...16 AWG

3.5 Mounting of electronic display unit



NOTE

The display can be rotated +/-270° in 90° steps during installation to improve readability.

NOTICE

Electrical connection to Pt1000 temperature sensor.

Risk of malfunction or damage



- Ensure not to pinch cable while mounting electronic display unit onto coupling.
- Guide cable around sensor dome
- Electronic display unit shall not be rotated more than 270° in same direction



NOTE

Tighten bolts of electronic display housing with 2Nm of torque to the coupling.

Factory setting of outputs

Output 1: Out.1 – Volume pulses: 50ms, 1Ltr/pulse (exception: DN15 is set to 0.1Ltr/pulse)

Output 2: Out.2 – Volume pulses: 50ms, 1Ltr/pulse (exception: DN15 is set to 0.1Ltr/pulse)

Analog: disabled

3.6 Engineering notes

Parameterizing ancillary devices

Some ancillary devices require programming of pulse values or frequency (see the relevant operating instructions).

The maximum frequency is calculated with the following formula:

$$\frac{\text{max. flow rate in liters/hour}}{\text{pulse value in liters} \times 3600} = \text{frequency in Hz} \leq 200\text{Hz}$$

4 Operation



NOTE

Modification of operation settings may result in faulty or wrong measuring results.

Multiple output functions are available, any of these functions can be used simultaneously.

2 potential-free digital outputs (Out.1 + Out.2), each freely programmable The passive current loop is also used to power the flow meter at the same time.

Default settings:

- Volume pulses; for external totalizer or monitoring systems.
- Flow / Frequency; output 0...200Hz corresponding to flow rate.
- Limiting switch; Switching function with programmable high and low flow rate (NO / NC).
- Status switch; control functions for Errors, Alarms and Supply Voltage (NO / NC).
- Analog current loop 4...20mA corresponding to actual flow rate or actual temperature of the medium

Compensation to Norm-Volume:

Compensation to norm-volume can be turned on, this means that the volumetric expansion of the medium is calculated using actual temperature to its normalized volume (15°C).

The following outputs will change from volume only to compensated norm-volume. Therefore, output values will have the following functions:

- Volume pulses; for external totalizer or monitoring systems (50% Duty cycle).
- Flow / Frequency; output 0...200Hz corresponding to flow rate.
- Analog current loop 4...20mA corresponding to actual flow rate or actual temperature of the medium.

Mass flow calculation:

Calculation to mass flow can be turned on, this means that the normalized volume of the medium based on base density (15°C) and actual temperature is calculated to mass / mass flow.

The relevant parameters are added and are displayed accordingly:

Therefore, the following outputs are added and can be set accordingly:

- Mass pulses; for external totalizer or monitoring systems.
- Mass Flow / Frequency; output 0...200Hz corresponding to mass flow rate.
- Analog current loop 4...20mA corresponding to actual mass flow rate.

4.1 Commissioning

Startup and commissioning of mechanical part of flow meter, without programming any electronic counter (VZF II and VZFA II).

Open valves slowly, fill pipework gradually. Vent the installation well.

Water hammer must be avoided in order not to damage the flow meter. Inclusions of air cause measuring errors in all types of flow meter and can damage them during operation.

Check the tightness of the connections watch for leakages.

Function check with electronic display: read the instantaneous flow value.

Should the established flow rate be greater than the specification of the flow meter (Q_{cont}), either a flow control valve (throttle) must be inserted behind the flow sensor or a larger size flow meter must be used.

4.2 Display and operation

The display shows 8-digits with a decimal point or text messages using letters. Units of measurement and additional items of information are shown with symbols.

The references to these are shown in square brackets, e.g. [o1VoLum].

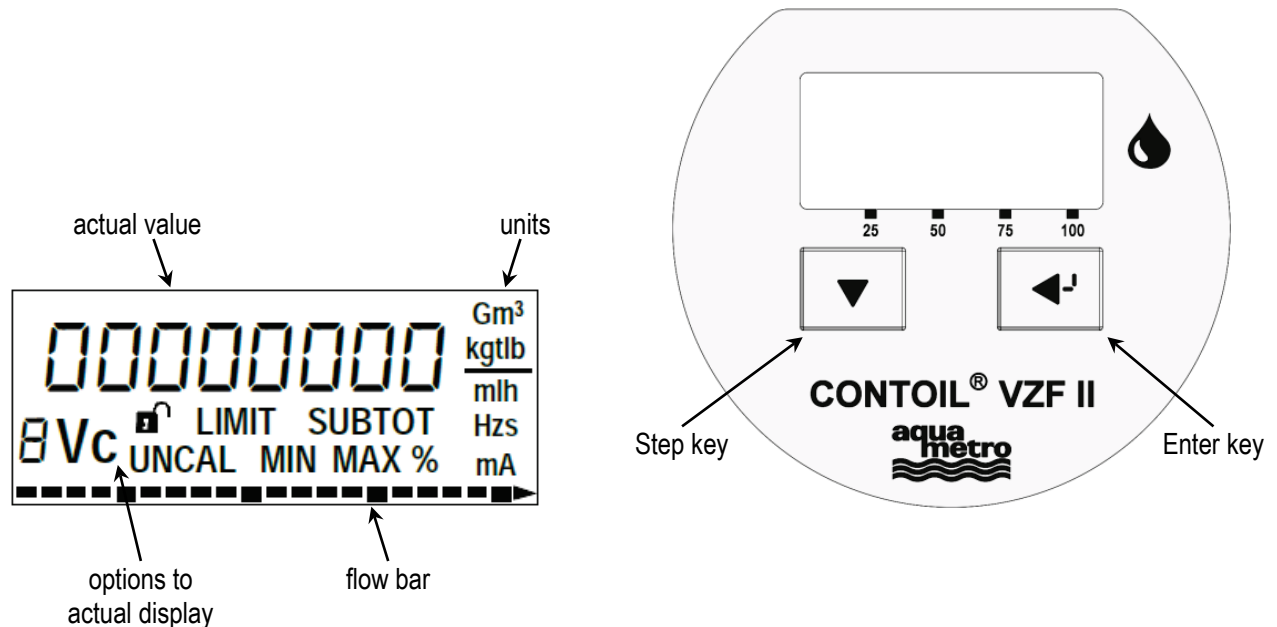

Use Step key  to scroll the menu and to change field values.

Use Enter key  to enter submenus and to edit / confirm field entries.



The display data and parameters are split into two menu groups:

- Main Menu: displays measured data, accesses other menus, tests display segments and displays error or alarm messages (if present).
- Setup Menu: displays parameter settings for the display, output signals, additional information about the flow meter and operating status.
When entering the access code, adjustment of parameters are possible

4.3 Parameterizing

In order to adjust the parameters, scroll to the [SEtUP] item from the Main Menu and press the Enter key .

No code is required to view parameters.

To adjust any parameter in the Seutp menu, the device must be unlocked () with the user code. Press both keys ( + ) simultaneously for 4 seconds until **[CodE0000] is displayed.**

Press Enter again and the first right digit will start flashing, which means, the unit is ready for the entry of the first digit of the **user code 1111.**

Enter the first digit by using the Step key. Press the Enter key to accept the value (in our case 1) and to move to the second right digit. Continue this way to enter all code digits.

At the end of the procedure a  will be displayed. The flow meter is now in the edit mode and parameters can be changed.

If no key is pressed within 1 minute, the device returns to the “home” display but the edit mode is still active (15 minute timeout). Any entries that have not been completed by pressing the Enter key are rejected.

Parameterizing the flow meter data

In order to guarantee accurate measurement, the electronic module of the flow meter requires adjustment. During factory calibration, the data for nominal size and the exact measuring chamber volume are entered for this purpose. These parameters cannot usually be changed again.

If the display shows **[UNCAL]** the flow meter is not calibrated.

If the electronic counter has to be replaced, please mention the serial number of the defective counter in your communication. Spare parts are set to the appropriate hardware size.

Reset of subtotalizers

To reset all subtotalizers, go to subtotalizer volume (*),

Press and hold both buttons for 4s until the counter are reset.

4.4 Main Menu

The **Main Menu** displays most important measured data and accesses the setup menu. The standard “Home” display of the Main Menu is the volume total [TOT], when Mass compensation is turned on the “Home” display is mass total [TOT].

Quick return to “home”: quickly press both key simultaneously.

Use the Step key to scroll through all the menu items, as follows:

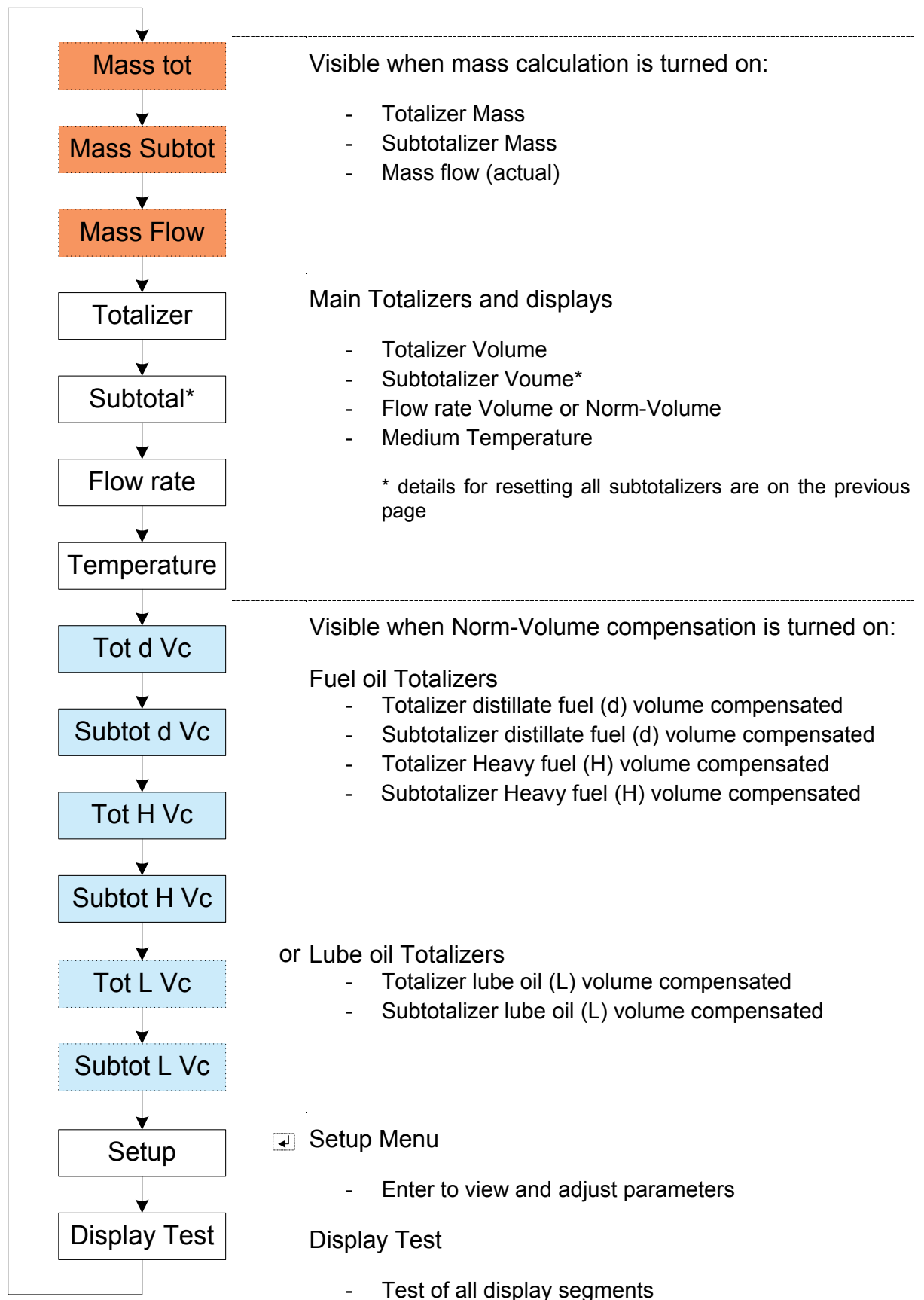

4.5 Setup menu structure

Setup Menu: shows settings for parameters, units and output signals.

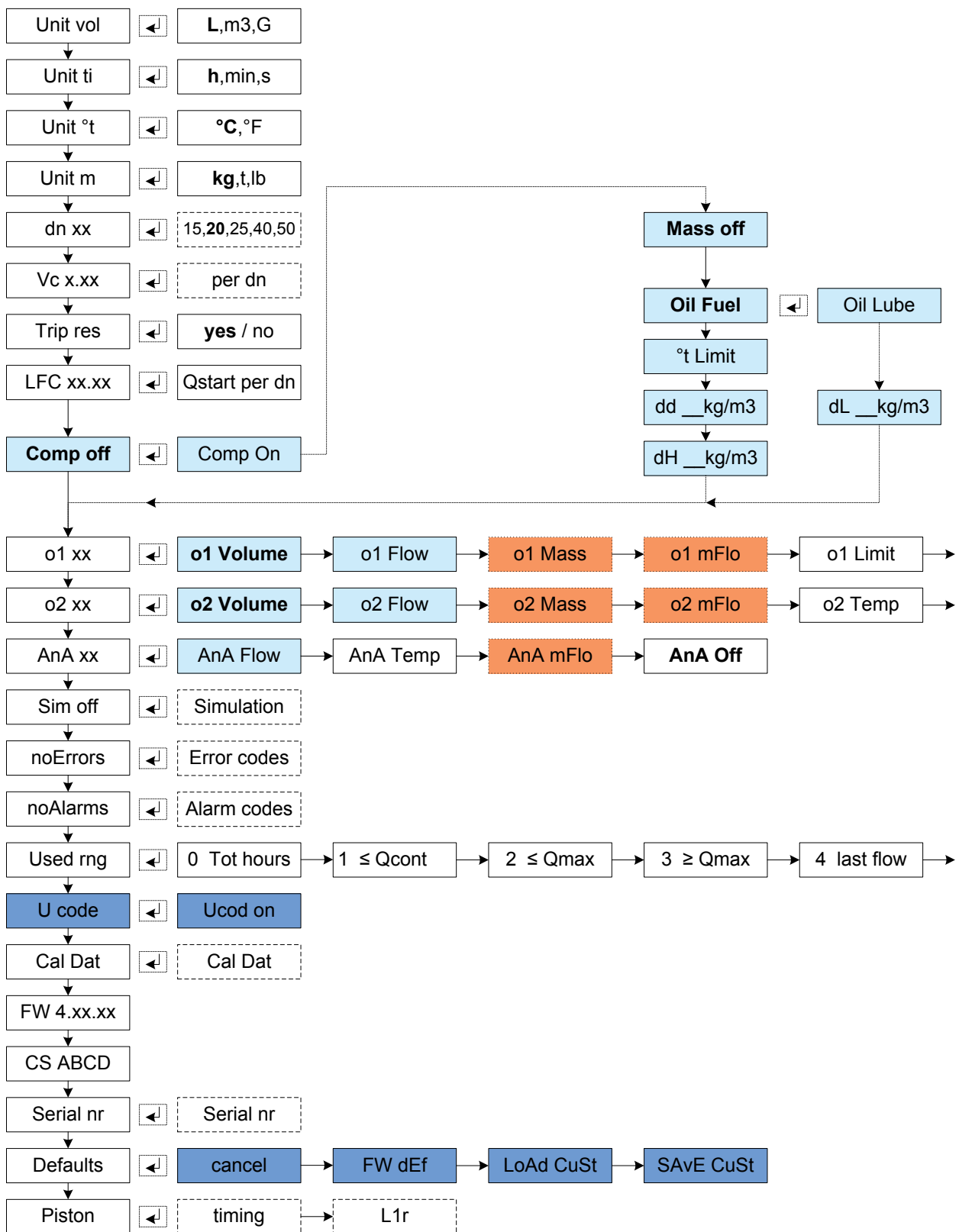

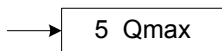
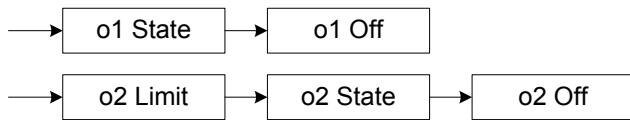

- hidden with user code
- view only
- Standard
- Volume Compensation
- visible when Mass Calc is on

4.6 Output assignment settings

Use Step key to scroll through output 1 / 2 options (volume, flow / frequency, mass, mass flow, limit, state and off). Technical output specifications can be found on page 37.

Output 1 settings

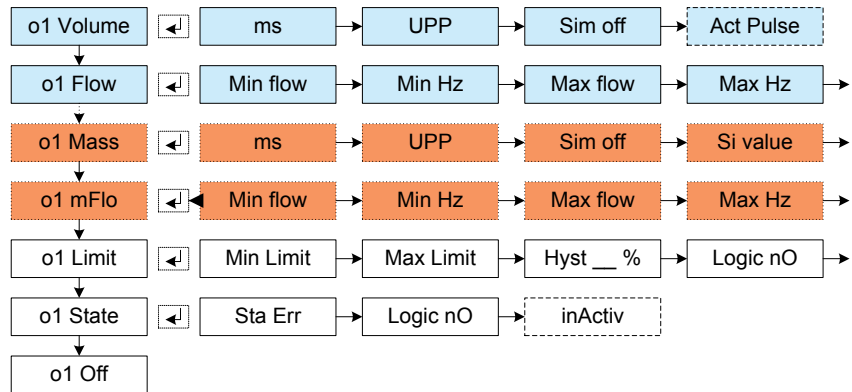

Output 2 settings

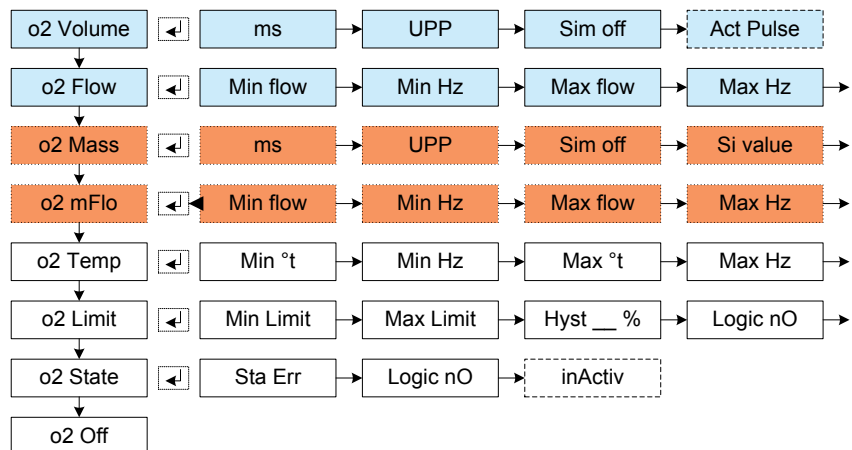

Analog current loop settings 4...20mA

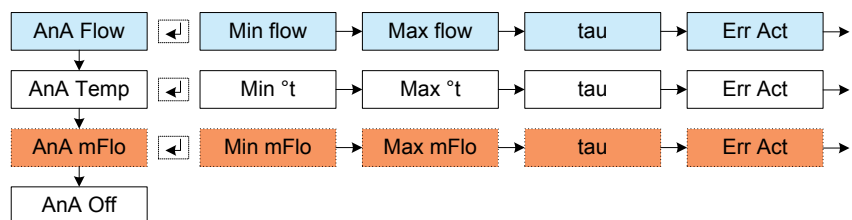

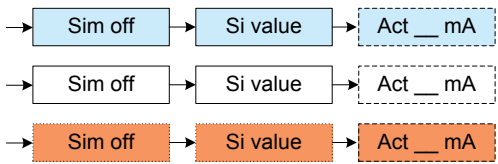
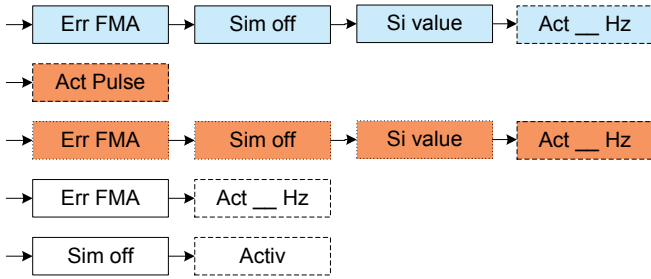
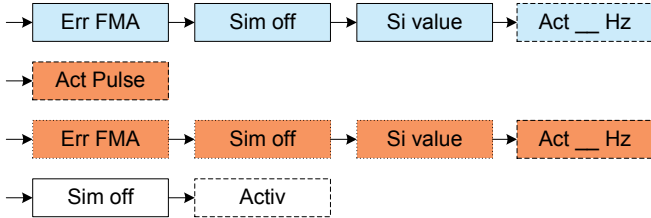

- hidden with user code
- view only
- Standard
- Volume Compensation
- visible when Mass Calc is on

4.7 Description of menu items

As they appear in the menu structure

Possible parameter units are described on page 44

Main Menu

Mass Tot	totalizer of mass flow in selected units
Mass Subtot	subtotalizer of mass flow
Mass Flow	mass flow
Totalizer	main totalizer of volume flow
Subtot	subtotalizer of volume flow
Flow rate	flow rate (volume compensated when Comp on is set, Vc is displayed)
Temperature	displays oil temperature in selected unit
Tot d Vc	main totalizer of compensated volume flow for distillate fuel
Subtot d Vc	subtotalizer of compensated volume flow for distillate fuel
Tot H Vc	main totalizer of compensated volume flow for heavy fuel
Subtot H Vc	subtotalizer of compensated volume flow for heavy fuel
Tot L Vc	main totalizer of compensated volume flow for Lube oil
Subtot L Vc	subtotalizer of compensated volume flow for Lube oil
Setup	displays all setup parameters (edit with user, service code)
Display test	Test of all display segments

Setup Menu

enter from Main Menu "SETUP"	
Unit vol	select units for volume display
Unit ti	select units for time display
Unit °t	select units for temperature display
Unit m	select units for mass display
Dn*	select nominal size of the hydraulics → pre set during calibration
Vc*	displays the volume of the measuring chamber → set after calibration
Trip res	select if trips (all subtotals) can be reset (yes, no)
LFC	select Low Flow Cut off (no counting below this value, displays zero [0])
Comp OFF	compensation is turned off (volume and mass)
Comp On	compensation is turned on (if mass is off, it will only compensate to Norm-Volume)
Mass OFF	Mass calculation is turned off
Mass On	Mass calculation is turned on (outputs are in mass)
Oil Fuel	select usage type Fuel oil
°t Limit	enter the thermal threshold for distillate and heavy fuel oil
dd 880kg/m ³	enter the density of currently used distillate fuel
dH 990 kg/m ³	enter the density of currently used heavy fuel
Oil Lube	select usage type Lube oil if counter is used to measure Lube oil
dL 900kg/m ³	enter the density of current Lube oil
o1 / o2 / AnA	Outputs, see details on next page
noErrors	no error messages
Errors	error messages displayed (see Troubleshooting for error message details)
noAlarms	no alarm messages
Alarms	alarm messages displayed (see Troubleshooting for alarm message details)

Used rng	Range where the counter been used in hours (h)
0	Total hours of operation (h)
1	hours of operation in preferred range (Qmin – Qcont)
2	hour of operation in upper flow range (Qcont – Qmax)
3	hours of operation above Qmax (h)
4	duration since last recorded flow (h)
5	maximum registered flow rate since start of operation
U Code*	select to enable / disable access with user code
FW 4.xx.xx	Firmware version
CS yyyy	Check Sum value (hexadecimal 4 digits)
Serial nr*	Serial number
Defaults*	select to save / load customer settings and reset to firmware defaults
Save Cust*	select to save customer settings
Load Cust*	select to load saved customer settings
FW def*	select to reset the device to firmware defaults
Piston	additional piston rotation timing information for service technicians
*edit access for service technicians only	

Outputs see Technical output specifications on page 37 for more details
oX = o1 or o2

oX Volume select when volume pulses are required (digital pulse)
oX Flow select when flow is required (frequency)
oX Mass select when mass pulses are required (digital pulse)
oX mFlo select when mass flow is required (frequency)
oX Limit select when a limit switch function is required
oX State select when the status of the device is required
oX OFF select to turn this output off
o2 Temp select when temperature with an frequency output is required
AnA Flow select when an analog current flow is required
AnA Temp select when an analog current temperature is required
AnA mFlo select when an analog current mass flow is required
AnA OFF select to turn the analog off
Sim OFF Simulation off, turn on to simulate individual outputs
Si 0.0000 enter a simulation value when simulation is on

Output settings

ms pulse width limit in milliseconds
UPP Units per pulse (the value of 1 pulse)
Act xx the actual value on output
Min flow lower flow rate value for frequency output (Qmin for o1/o2)
Min Hz lower frequency value of frequency output (fmin for o1/o2)
Max flow upper flow rate value of frequency output (Qmax for o1/o2)
Max Hz upper frequency value of frequency output (fmax for o1/o2)
Err FmA behavior during error of output (set to fMAX as defined in settings (o1/o2)
Err Act behavior during error of output (actual value; error suppression)
Err Low behavior during error of output (output signal is at low limit 3.5mA)
Err High behavior during error of output (output signal is at high limit 21.5mA)
Min Limit lower flow rate limiting value
Max Limit upper flow rate limiting value
Hyst x% hysteresis in percent of limiting value
Logic NO logic function NO (normally open)
Logic NC logic function NC (normally closed)
Activ status of logic output is active
inActiv status of logic output is inactive
Min °t lower temperature value for frequency output (Tmin for o1/o2)
Min Hz lower frequency value of frequency output (fmin for o1/o2)
Max °t upper temperature value of frequency output (Tmax for o1/o2)
Max Hz Upper frequency value of frequency output (fmax for o1/o2)
Min mA lower value for the analog current signal of 4mA
(valid for flow, temp & mass flow)
Max mA upper value of the analog current signal of 20mA
(valid for flow, temp & mass flow)

5 Maintenance and Repair

5.1 Calibration

All our flow meters are calibrated in the factory.

An accuracy check and recalibration is offered at Aquametro AG, this is usually dependent on customer, operator or regulation requirements. This interval depends largely on the operating conditions, process liquid and the application the flow meter is installed in.

5.2 Service maintenance

CAUTION

The surfaces of the device/system and the medium may be hot.



Risk of burns!

- Carry out work only on cooled devices/systems.
- Work may only be performed by authorized specialists in accordance with the applicable regulations.
- Use appropriate protective equipment.

WARNING

The device/system may be under pressure.



Risk of severe injury!

- Carry out work only on non-pressurized systems.
- When working on the device/system watch out for leaking medium.
- Work may only be performed by authorized specialists in accordance with the applicable regulations.
- Use appropriate protective equipment, particularly safety goggles

NOTICE



Use of unsuitable cleaning agents and procedures.

Risk of malfunction or damage

- Follow the cleaning instructions on the next page.

NOTICE



Warranty will be void, if the flow meter is being opened during the warranty period by a non Aquametro AG certified person.

Before working on the hydraulics:

- put the system or section out of operation
- close the stop valves
- release the pressure
- put a suitable tray underneath the connection to be worked on
- be prepared for spillage, have absorbent at hand

Cleaning of flow meter:

- do not use any aggressive solvents
- rinse hydraulic part of flow meter thoroughly

Aquametro AG recommends to use the following cleaning solvents:

- Gasoline used for cleaning purposes
- Cleaner’s naphtha
- Petroleum ether

Dirt filter (not safety filter of flow meter)

Dirt filters must be cleaned periodically, initially at short intervals to keep fuel system free of dirt and debris.

To restart the system:

- slowly open the stop valves, avoiding pressure surges (“water hammer”)
- vent the pipe well
- check tightness

Maintenance

Check connections periodically for tightness and if necessary retighten. For control and cleaning, the measuring chamber and the ring piston of the flow meters DN15 - 50 can be removed without dismantling the flow meter from the pipe.

Torque values of screws		
Flow meter	Screws	Torque
Electronic unit	M 4	2 Nm
Coupling	M 6	4.5 Nm

Torque of measuring chamber screws		
Flow meter	Screws	Torque
DN 15,20	M 6	6 Nm
DN 25	M 8	16 Nm
DN 40	M 12	47 Nm
DN 50	M 16	100 Nm

The cleaning and revision cycle depends largely on the conditions of operation. Under favourable conditions 5-10 years suffice. Check the devices for corrosion.

Recommended revision cycle

Flow meter.	Totalizer Volume	Time
DN 15	20'000 m ³	7 years
DN 20	50'000 m ³	
DN 25	100'000 m ³	
DN 40	300'000 m ³	
DN 50	1'000'000 m ³	

The responsibility of the revision cycles lies with the operator.

NOTICE

If opening is necessary:

Risk of malfunction!



- Observe positions during disassembly
- Follow assembly instructions
- Check proper function at start up
- Recalibration is recommended after service
- For more information about maintenance, request document VI 14-419.

Opening and closing

For instruction on opening and closing the flow meter please refer to our webpage.



See Spare part list and Maintenance instructions VI14-419

5.3 Spareparts

NOTICE



Use of wrong Spare parts

Risk of malfunction or damage

- Use only original spare parts, supplied by Aquametro AG



Spare part list and Maintenance instructions VI14-419 may be requested from Aquametro AG.

6 Troubleshooting

6.1 For all CONTOIL® flow meter

Fault symptoms	Possible causes	Procedures
<ul style="list-style-type: none"> No reading / blank display 	<ul style="list-style-type: none"> No power supply Electronic counter defective 	<ul style="list-style-type: none"> Check wiring, polarity Replace electronic counter Mention SN during order
<ul style="list-style-type: none"> Counter not running No flow rate indicated Indicated quantity or flow rate too small 	<ul style="list-style-type: none"> Flow rate outside allowed range (below Q_{\min} or above Q_{\max} of meter) Moving parts heavily worn out due to continuous overload Dirt trap / filter heavily soiled Safety filter in meter intake clogged Moving parts jammed Alignment of inner parts Separating plate broken by <ul style="list-style-type: none"> Pressure hammer Gas inclusions 	<ul style="list-style-type: none"> Check flow rate (reverse flow) totalizer "0" If too high, reduce flow or install larger meter If too low, increase flow or install smaller meter Reduce LFC to 1 install larger meter Clean dirt trap, replace filter Replace safety filter Install dirt trap / filter with correct mesh size clean measuring chamber, replace defective parts align cover and measuring chamber (rip to rip) Check and rectify operating conditions and meter position Fill pipes slowly De-aerate pipes thoroughly replace defective parts
<ul style="list-style-type: none"> Totalizer(s) runbackwards 	<ul style="list-style-type: none"> Meter mounted in wrong direction 	<ul style="list-style-type: none"> Install meter with arrow pointing in flow direction
<ul style="list-style-type: none"> Indicated quantity or flow rate too high 	<ul style="list-style-type: none"> Meter positioned wrongly (e.g. at highest point) Gas or air inclusion in fluid 	<ul style="list-style-type: none"> Check and rectify operating conditions and meter position De-aerate pipes carefully
<ul style="list-style-type: none"> pressure drop at meter too high 	<ul style="list-style-type: none"> Dirt trap or filter heavily soiled Flow meter's safety filter heavily soiled 	<ul style="list-style-type: none"> Clean dirt trap, replace filter Clean safety filter of flow meter
<ul style="list-style-type: none"> No frequency signal No current signal No pulse output signal 	<ul style="list-style-type: none"> No flow Wrong parameterisation Transducer defective 	<ul style="list-style-type: none"> Check flow using Indication Set correct parameters for outputs Replace transducer

6.2 Error messages VZF II / VZFA II

The electronic module performs a self-test about every 5 minutes. If an error is detected which impairs the reliability or accuracy of the measurement, **[ERROR]** message will appear every 2 seconds on the display.

Error messages are messages from the electronic module.

[nO ErrS] no error is active

Action: none

[E-FLOW] maximum permitted flow rate (Q_{max}) exceeded The flow meter is mechanically overloaded and is no longer measuring accurately.

Action: reduce the flow rate or use higher nominal size.

[E-Prom] error with the Checksum of the Software saved in ROM.

Action: Please contact the supplier.

[E-SENSOR] signal error from flow sensor to electronic module, flow meter supplies incorrect measured values.

Action: electronic module must be replaced. Please contact the supplier.

[E-EEP o1] EEPROM error in output 1 parameters

Action: Go to [DEFAULTS] correct output1 memory block (under USER Code).

[E-EEP o2] EEPROM error in output 2 parameters

Action: Go to [DEFAULTS] correct output2 memory block (under USER Code).

[E-EEPANA] EEPROM error in Analog current loop parameters

Action: Go to [DEFAULTS] correct analog current loop memory block (under USER Code).

[E-EEPLIN] Linearisation table is corrupt, device runs in standard mode

[E-Pt1000] temperature is out of range (-60°C...+200°C), broken or shorted contact

Action: check connector and cable of Pt1000.

[E-EEPDEV] EEPROM error in device

Action: measurement transducer must be replaced. Please contact the supplier.

[E-EEPTOT] EEPROM error in Totalizer. Totalizer value may be incorrect.

Action: Go to [DEFAULTS] correct Totalizer memory block (under USER Code).

CAUTION, Totalizer value is lost.

[E-EEPTRP] EEPROM error in Trip Totalizer. Trip Totalizer value may be incorrect.

Action: Go to [DEFAULTS] correct Trip Totalizer memory block (under USER Code).

CAUTION, Trip Totalizer is lost.

[E-EEPFAT] EEPROM error in File System.

Action: electronic module must be replaced. Please contact the supplier.

6.3 Alarm messages VZF II / VZFA II

The electronic module performs a self-test about every 5 minutes. If an alarm condition is detected, **[ALARM]** message will appear on the display every 2 seconds.

Alarm messages are messages from the parameter settings

[nO ALmS] no alarm is active

Action: none.

[A-SEnSSI] alarm when sensor simulation is activated (Service Technician only).

Action: none. CAUTION Totalizer and Trip Totalizer accumulate the simulated value.

[A-o1 SI] alarm when output 1 simulation is activated.

Action: turn off when not required anymore.

[A-o2 SI] alarm when output 2 simulation is activated.

Action: turn off when not required anymore.

[A-ANA SI] alarm when Analog current loop outputsimulation is activated.

Action: turn off when not required anymore.

[A-o1 LI] alarm when output 1 is over its limit.

Action: adjust the settings of output1.

[A-o2 LI] alarm when output 2 is over its limit.

Action: adust the settings of output2.

[A-AnA LI] alarm when Analog current loop outputis over its limit.

Action: adust the settings of analog current loop output.

7 Decommissioning, Dismantling and Disposal

CAUTION

The surfaces of the device/system and the medium may be hot.



Risk of burns!

- Carry out work only on cooled devices/systems.
- Work may only be performed by authorized specialists in accordance with the applicable regulations.
- Use appropriate protective equipment.

WARNING

The device/system may be under pressure.



Risk of severe injury!

- Carry out work only on non-pressurized devices/systems.
- When working on the device/system watch out for leaking medium.
- Work may only be performed by authorized specialists in accordance with the applicable regulations.
- Use appropriate protective equipment, particularly safety goggles

7.1 Decommissioning

Disconnect all sources of energy.
Remove the flow meter from system
Follow disposal instruction 7.3

7.2 Dismantling

Not required.

7.3 Disposal

At the end of the life cycle, this product should be disposed of according to local regulations regarding waste recycling or disposal.



The separate collection and recycling of old products will help to conserve natural resources and ensure that they are disposed of in a manner ensuring the protection of environment and nature.

8 Technical Data

8.1 Hardware characteristics

Hydraulics

Type			VZF(A) II 15	VZF(A) II 20	VZF(A) II 25	VZF(A) II 40	VZF(A) II 50
Nominal diameter	DN	mm	15	20	25	40	50
		inch	1/2	3/4	1	1 1/2	2
Installation length		mm	165	165	190	300	350
Nominal pressure with threaded ends	PN	bar	16	16	16	16	16
		with flanges	bar	25 / 40	25 / 40	25 / 40	25 / 40
Maximum temperature Tmax		°C	130, 180 ¹⁾				
Maximum flow rate ²⁾	Qmax	l/ h	600	1500	3 000	9 000	30 000
Continuous flow rate	Qcont	l/ h	400	1000	2 000	6 000	20 000
Minimal flow rate	Qmin	l/ h	20	40	75	225	750
starting flow rate		l/ h	4	12	30	90	300

¹⁾See below temperature ²⁾short time period (e.g. <1h / 24h)

VZF II / VZFA II electronics

- Temperature: ambient temperature -25...+70°C, max medium 150°C
ambient temperature -25...+50°C, max medium 180°C
storage temperature -25...+85°C
- Humidity: storage humidity max 95% none condensing
- Safety: CE, vibration and shock test to DIN IEC 68 (electronics)
- Data preservation: by non-volatile memory (EEPROM)
- Protection class: IP66/IP68/IP69 (IEC 60529) against dust, Water submersion and against high-pressure jet

Power supply and / or analog output (terminal 1-2)

- Voltage range (U): 6...30VDC
- Analog output: 4...20mA passive
- Resolution: 16 Bit
- Max. error: ±0.2mA
- Update interval: <0.1s
- Maximum Load (RL): 0 to 1116Ω, depending on external supply voltage of the power supply unit $\frac{U-6}{0.0215} \Omega$; (e.g.: 1116Ω@30V)

Digital output (terminal 3-4, 5-6)

- Output (Out1 & Out2): 2 potential-free contacts
- Max. voltage U_{max} : 48VAC/VDC
- Max. current I_{max} : 50mA
- Max. output freq. f_{max} : 200Hz
- Update interval: <1ms
- ON-resistance R_0 : $\leq 50\Omega$
- OFF-resistance R_∞ : $\geq 10M\Omega$
- Isolation voltage: >100VAC/VDC

8.2 Parameterizing the VZF II / VZFA II outputs

In order to set the parameters, the device must be unlocked with the user code

Volume pulse output for summing the flow volume (totalizer)

Setup menu: function for Output1 or Output2

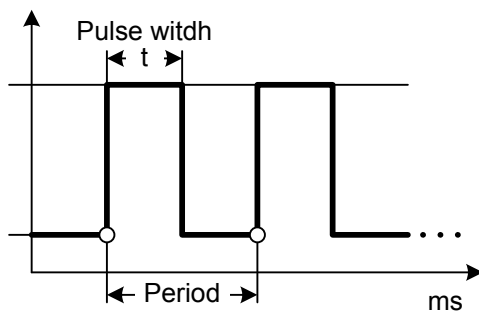

Pulse width (t):

The pulse width limit can be set between 2...500ms (example: 20ms).

The actual pulse width is dynamically adjusted based on the current flow, but at least the set value.

The duty cycle is 50%.

Signal behavior:

The signal is defined as 50% ON and 50% OFF:

Parameters that can be set:

Pulse width (t): 2...500ms

(Volume or Norm-Volume pulses)

Pulse value for liters [UPP]: 0,0001...1000Ltr / pulse

Pulse value for m^3 [UPP]: 0,0001...1000 m^3 / pulse

Pulse value for US gallons [UPP]: 0,0001...1000gallon / pulse

(Mass pulses)

Pulse value for kilo grams [UPP]: 0,0001...1000kg / pulse

Pulse value for tons [UPP]: 0,0001...1000t / pulse

Pulse value for US lbs [UPP]: 0.0001...1000lb / pulse

factory setting:

**DN20 – 50 are set to 50ms and 1UPP
(DN15 is set to 0.1UPP)**

Flow / Frequency output

Setup menu: function for Output1 or Output2

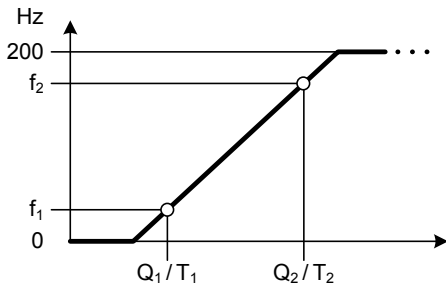

Frequency range and proportionality of the signal across the desired flow rate / temperature measurement range $Q_1/T_1 - Q_2/T_2$

Signal behavior:

If the flow falls below the set lower flow rate value, a proportional decrease to 0Hz will occur, which is then maintained until the flow rises over the lower flow rate again.

If the flow exceeds the set upper flow rate value, a proportional increase to 200Hz will occur, which is then maintained until the flow falls below the lower flow rate again.

On Error, select between **[Err FmA]** (frequency max; sends max. frequency) or **[Err Act]** (actual value; error ignored)

Parameters that can be set:

(Volume or Norm-Volume flow)

Lower flow rate [MIN]:	$Q_1/T_1 \geq 0$	<i>(factory setting: Qmin)</i>
Lower frequency [Hz]:	$f_1 \geq 0$	<i>(factory setting: 20Hz)</i>
Upper flow rate [MAX]:	$Q_2/T_2 \leq Q_{max}$.	<i>(factory setting: Qcont)</i>
Upper frequency [Hz]:	$f_2 \leq 200\text{Hz}$	<i>(factory setting: 200Hz)</i>
Error [Err]		<i>(factory setting: Err FmA)</i>

Notice: **Qmin**, **Qcont** and **Qmax** are dependent on the nominal size of the flow meter.

Example:

Lower flow rate: 30ltr. (Q_1) by a frequency of 20Hz (f_1)

Upper flow rate: 2000ltr. (Q_2) by a frequency of 160Hz (f_2)

A flow range of 1970ltr (2000-30) and a frequency range of 140Hz (160-20).

The flow range will be spread accross the range of 140Hz.

That means, $1970\text{ltr.} / 140\text{Hz} = 14.1\text{ltr/Hz}$.

In other words, for a delta of 1Hz there is an increase of 14.1ltr.

Limiting output

Setup menu: function for Output1 or Output2

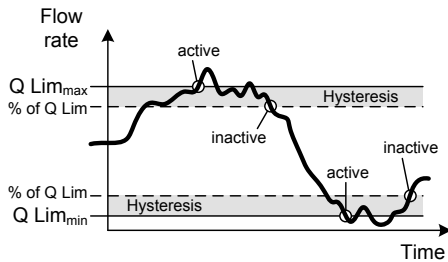

	Work State	
	NC	NO
active	/—	/—
inactive	/—	/—

The function Limit allows you to set an alert whenever predefined flow rates are exceeded.

Signal behavior:

Limit defines upper ($Q\ Lim_{max}$) and lower ($Q\ Lim_{min}$) flow rate thresholds which, when exceeded, activate a switch (alert). In order to prevent oscillating between active and inactive states when the flow rate fluctuates about a threshold, hysteresis bands (see adjacent diagram) can be defined in which the switch will remain active once it has been triggered to this state. When the flow rate passes below or above these bands, the switch will be deactivated.

The hysteresis bands are calculated as a percentage of the threshold values ($Q\ Lim$).

The switch can be used for remote control or alarm systems.

Parameters that can be set:

Lower flow rate [**LIMIT MIN**]:

$$QLim_{min} \geq 0$$

(factory setting: Q_{min})

Upper flow rate [**LIMIT MAX**]:

$$QLim_{max} \leq Q_{max}$$

(factory setting: Q_{cont})

Hysteresis [**HYST**]:

$$0 \dots 9\%$$

(factory setting: 1%)

The switches that are activated by the above parameters can be set to NO (Normally Open) or to NC (Normally Closed). This choice is dependent on your needs.

Limit switch [NO]:

Contact closes when the limits are exceeded .









Limit switch [NC]:

Contact opens when the limits are exceeded.

Example:

- If the limit [**LIMIT MIN**] is set to 100l/h and [**HYST**] is set to 5%, then the hysteresis is 5% of 100l/h or 5l/h. This means that as soon as the flow rate rises above 105l/h the switch will be deactivated if it is active.
- If the limit [**LIMIT MAX**] is 200l/h and [**HYST**] is set to 5%, then the hysteresis is 5% of 200l/h or 10l/h. If the switch is active then it will be deactivated as soon as the flow falls below 190l/h.

State output according to signal faults
 Setup menu: function for Output1 or Output2

		Work State	
		NC	NO
active			
			
inactive			
			

Whenever an error or an alarm occurs, you can send it with this selected output.
 Any fault (Error, Alarm or power loss) can be sent to a remote control or alarm system.

Parameters that can be set:

Available fault setting:

[Err, ALm or VCC (VCC = loss of power supply)]
(factory setting: Err)

Select contact logic:

[NO] or [NC]
(factory setting: NO)

Analog current loop (4...20mA)

Setup menu: Analog current loop

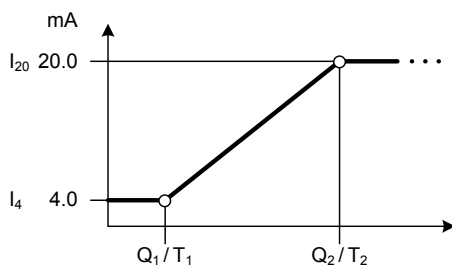

I_4 : current 4mA
 I_{20} : current 20mA
 Q_1 : chosen min. flow rate
 T_1 : chosen min. temperature
 Q_2 : chosen max. flow rate
 T_2 : chosen max. temperature

The current signal is proportional to the flow rate or temperature range of Q_1/T_1 to Q_2/T_2

Signal behavior:

when a relevant flow meter error occurs:

- Value falls below the set lower flow rate / temperature value Q_1/T_1 : proportional decrease to 3.8mA which is then maintained.
- Value exceeds the set upper flow rate / temperature value Q_2/T_2 : proportional increase to 20.8mA which is then maintained.

(continuing output of actual value 3.8 – 20.8mA).

- Error signal for measurement relevant error (sensor, ROM, supply voltage, etc.)
 For HIGH error behavior: output 21.5mA
 For LOW error behavior: output 3.5mA
 For ACT error behavior: no error signal,

Damping of the signal [tAU] for rapidly changing values.

Note: The higher the time constant, the more sluggish the signal. This parameter is used to avoid “jumps” of the signal

Parameters that can be set:

Lower value [MIN]:	$Q_1/T_1 \geq 0$	(factory setting: $Q_{min} / 0^\circ\text{C}$)
Lower current [mA]:	$I_4 = 4\text{mA}$	
Upper value [MAX]:	$Q_2/T_2 \leq Q/T_{max}$	(factory setting: $Q_{cont} / 100^\circ\text{C}$)
Upper current [mA]:	$I_{20} = 20\text{mA}$	
Error [Err]		(factory setting: $Err\ Act$)
Notice:	Qmin , Qcont and Qmax are dependent on the nominal size of the flow meter.	

[tAU] Damping value (Tau)

1 (no damping) ... 9 (max. damping)

(factory setting: 4)

Example:

Q_1 is 50l/h and Q_2 is 500l/h

By 50l/h a signal of 4mA is being sent

By 275l/h a signal of 12mA is being sent

By 500l/h a signal of 20mA is being sent

the flow range of 450l/h, will be distributed across the range of 16mA (20mA-4mA).

8.3 Dimensional drawings

Flow meters

All flow meters with threaded ends are according to ISO 228-1

DN15, 20, 25: with threaded ends

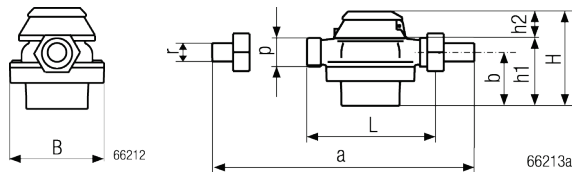

DN40: with threaded ends

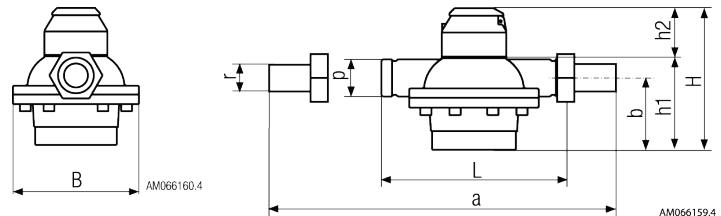

All flow meters with flanges are according to EN 1092-2, ASME B16.5 or JIS B2220

DN15, 20, 25: with flanged ends

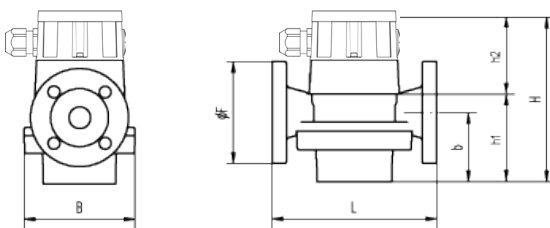

DN40, 50: with flanged ends

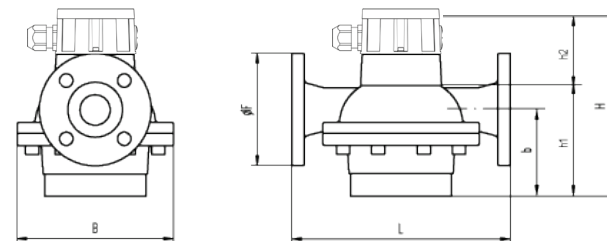

Nomial size	L	B	a	Ø F	b	h1	p	r
DN15	165	105	260	95	45	65	G 3/4"	G 1/2"
DN20	165	105	260	105	54	74	G 1"	G 3/4"
DN25	190	130	305	115	77	101	G 1 1/4"	G 1"
DN40	300	210	440	150	116	153	G 2"	G 1 1/2"
DN50	350	280	-	165	166	209	-	-

Dimensions in mm

*h2 is explained on next page

Dimensions of electronic counter

VZF(A) II Dimensional drawing

VZF II / VZFA II

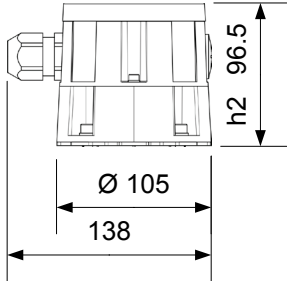

8.4 Display of electronic counter

VZF II / VZFA II

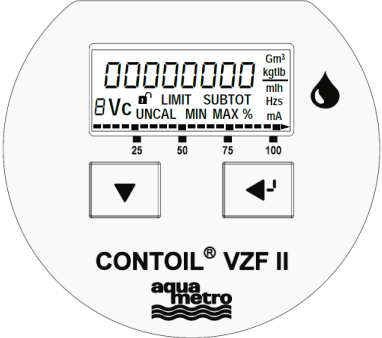

8.5 Default settings VZF II / VZFA II

Total counter mass	unit selected in Unit volume
Trip counter mass	unit selected in Unit volume
Actual mass flow	unit selected in Unit volume and Unit time
Total counter	unit selected in Unit volume
Trip counter	unit selected in Unit volume
Actual flow	unit selected in Unit volume and Unit time
Temperature	medium temperature in unit selected in Unit temperature
Total counter dist. Fuel	unit selected in Unit volume
Trip counter dist. Fuel	unit selected in Unit volume
Total counter Heavy Fuel	unit selected in Unit volume
Trip counter Heavy Fuel	unit selected in Unit volume
Total counter Lube oil	unit selected in Unit volume
Trip counter Lube Oil	unit selected in Unit volume
Setup menu	
Unit volume	<i>L</i> , G, m ³
Unit time	s, min, <i>h</i>
Unit temperature	°C, °F
Unit mass	kg, t, lb
Nominal size*	15, 20 , 25, 40, 50
Measuring chamber*	default: per selected size, or calibrated value
Trip Reset	
Reset yes / no	<i>yes</i> , no
Low flow cut off	<i>Qstart</i> , 0...Qmin
Compensation	<i>off</i> , on
Mass Compensation	<i>off</i> , on
Oil Fuel	<i>Oil Fuel</i> , Oil Lube
°t Limit	60°C , 0...200°C (32...392°F)
dd__kg/m3	880kg/m³ , 800...1200kg/m ³
dH__kg/m3	990kg/m³ , 800...1200kg/m ³
dL__kg/m3	900kg/m³ , 800...1200kg/m ³
Output 1	<i>Volume</i> , Flow, Mass, Mass Flow, Limit, State, off
Volume output	
Pulse width	50ms , 2...500ms
Liter per pulse	1UPP , 0.001...1000UPP [0.1UPP DN15]
Simulation	<i>off</i> , on
Sim value	0...Qmax (max. 9999.9)
Actual output	display flashes [Act Pulse] when active
Flow output	
Min Flow	<i>Qmin</i> , 0...Qmax
Min Frequency	20Hz , 1...200Hz
Max Flow	<i>Qcont</i> , 0...Qmax
Max Frequency	200Hz , 1...200Hz
Error behavior	<i>FMA</i> , Act
Simulation	<i>off</i> , on
Sim Value	0...Qmax (max. 9999.9)
Actual output	displays actual frequency on output [Act Hz] when active

Mass output	
Pulse width	50ms , 2...500ms
Liter per pulse	1UPP , 0.001...1000UPP [0.1UPP...DN15]
Simulation	off , on
Sim value	0...Qmax (max. 9999.9)
Actual output	display flashes [Act Pulse] when active
Mass Flow output	
Min Flow	Qmin , 0...Qmax
Min Frequency	20Hz , 1...200Hz
Max Flow	Qcont , 0...Qmax
Max Frequency	200Hz , 1...200Hz
Error behavior	FMA , Act
Simulation	off , on
Sim Value	0...Qmax (max. 9999.9)
Actual output	displays actual frequency on output [Act Hz] when active
Limit output	
Limit min	Qmin , full range of size
Limit max	Qmax , full range of size
Hysteresis	1% , 1...9% (possible rename to Threshold)??
Logic position	Logic Hi , Logic Lo
Simulation	off , on
Sim value	0...Qmax (max. 9999.9)
Actual output	displays actual state on output [Act on] / [Act off]
State output	
State behavior	Error , Alarm, UCC
Logic position	Logic Hi , Logic Lo
Actual output	displays actual state on output [Act on] / [Act off]
Output disabled	
Output 2	Volume , Flow, Mass, Mass Flow, Temperature, Limit, State, off
Same as output 1	
Temperature output	temperature is additional to output 1
Min Temperature	20°C / 68°F , 0...Tmax
Min Frequency	20Hz , 1...200Hz
Max Temperature	100°C / 212°F , 0...Tmax (Tmax = 200°C / 392°F)
Max Frequency	200Hz , 1...200Hz
Error behavior	FMA , Act
Simulation	off , on
Sim Value	0...Qmax (max. 9999.9)
Actual output	displays actual frequency on output [Act Hz] when active
Analog Output Flow	disabled , enabled
Min Value	0 , 0...Qmax
Max Value	Qcont , 0...Qmax
tAU value	4 , 0...9
Error behavior	off , High, Low
Simulation	off , on
Sim value	0...Qmax (max. 9999.9)
Actual output	displays actual current on output [Act mA] when active

Analog Output Temperature	<i>disabled</i> , enabled
Min Value	20 , 0...Tmax
Max Value	100°C / 212°F , 0...Tmax (Tmax = 200°C / 392°F)
tAU value	4 , 0...9
Error behavior	off , High, Low
Simulation	off , on
Sim value	0...Qmax (max. 9999.9)
Actual output	displays actual current on output [Act mA] when active
Analog Output Mass Flow	<i>disabled</i> , enabled
Min Value	0 , 0...Qmax
Max Value	Qcont , 0...Qmax
tAU value	4 , 0...9
Error behavior	off , High, Low
Simulation	off , on
Sim value	0...Qmax (max. 9999.9)
Actual output	displays actual current on output [Act mA] when active
Simulation Sensor*	off , on
Sim value	0...Qmax (max. 9999.9)
Errors	
Error messages.	see Technical Data
Alarms	
Alarm messages	see Technical Data
Range	
h0	total operating time t
h1	t in preferred flow range
h2	t in upper flow range
h3	t above Qmax
h4	t since last flow
5	Peak flow
U Code*	access with user code on / off
Cal Date*	date of calibration
Date value	dd.mm.yy, 31.12.99
Verification Date*	date of verification (CE devices only)
Date value	dd.mm.yy, 31.12.99
Firmware	4.xx.xx
Checksum	yyyy (hexadecimal 4 digits)
Serial Number*	7 digits
Defaults*	
Cancel	abort (back to menu)
FW def	reset of all parameters to factory settings
Save Cust	save customer settings to device
Load Cust	load customer settings from device
Piston	
Rev timing	advanced mechanical informations
Display test	
Alarm message	shown if applicable
Error message	shown if applicable

Default settings are in **bold - italic** letters

*edit access for service technicians only

9 Appendix

9.1 Certificates

All the below mentioned certificats / approvals, can be found on our web site
www.aquametro.com

Marine approval classifications

Det Norske Veritas - German Lloyd	Norway - Germany	
Lloyds Register	United Kingdom	

Versions with type approval and metrological CE approval

These versions of the CONTOIL[®] oil flow meter bear the number of the type test certificate in accordance with Directive 2004/22/EU (MID) and the metrological CE mark.
This means that they can be used for CE-compliant measurements in accordance with local laws / regulations.



For details please request document VD4-319def.

SWITZERLAND:	Aquametro AG, CH-4106 Therwil	info@aquametro.com	www.aquametro.com
	Aquametro SA, CH-1800 Vevey	info@aquametro.com	www.aquametro.com
	Aquametro AG, CH-6929 Gravesano	info@aquametro.com	www.aquametro.com
	bill24 AG, CH-8306 Brüttisellen	info@bill24.ch	www.bill24.ch
BELGIUM:	Aquametro Belgium SPRL, B-1933 Sterrebeek	info.amb@aquametro.com	www.aquametro.be
CHINA:	Aquametro (S.E.A.) Pte Ltd., Singapore 757516	info.china@aquametro.com	www.aquametro.com
GERMANY:	Aquametro Messtechnik GmbH, D-28329 Bremen	info.amd@aquametro.com	www.aquametro.de
	Aquametro Marine GmbH, D-18119 Rostock-Warnemünde	info.amd-marine@aquametro.com	www.aquametro.de
INDIA:	Aquametro Representative Office, Mumbai 400053	info.india@aquametro.com	www.aquametro.in
JAPAN:	Aquametro Representative Office, Tokyo 152-0031	info.japan@aquametro.com	www.aquametro.jp
KOREA:	Aquametro Korea Ltd., Busan 612-857	info.korea@aquametro.com	www.aquametro.kr
SINGAPORE:	Aquametro (S.E.A.) Pte Ltd., Singapore 757516	info.singapore@aquametro.com	www.aquametro.sg
UAE:	Aquametro ME JLT, Dubai / UAE	info.dubai@aquametro.com	www.aquametro.ae