Thermostatic Radiator Valves



A thermostatic unit for every application



2260 thermostat with internal sensor is used when the room air can pass freely over the sensor.



2290 Remote sensing and adjusting unit for the control of inaccessible valves.



2270 thermostat with 6' remote capillary sensor

A wide range of valve bodies

ISTEC thermostatic valves need no external power, they maintain the room temperature by controlling the flow of hot water or steam.

The valvebody is made of non-corrosive nickel-plated bronze/brass.

The valve stem and spring are made of stainless steel. The valve disc and "O"-ring are made of high temperature EPDM.

The valves are available in straight, angle and horizontal angle patterns.

The ISTEC valve cartridge can be exchanged while valves are installed and the system is under pressure by using the specially designed "demo-bloc" tool.

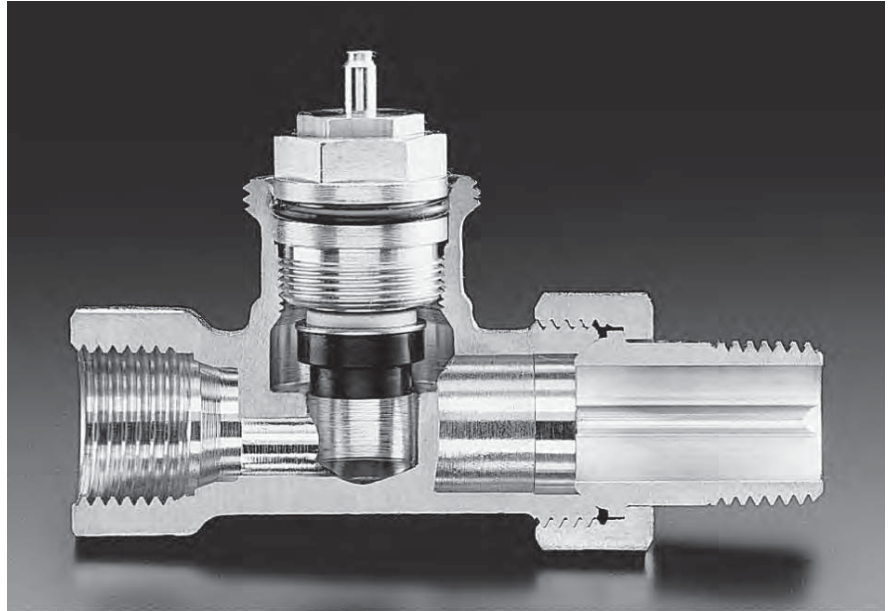

Applications

For one and two pipe central heating systems. Suitable for both forced hot water and steam applications.

What are the advantages of ISTEC valve bodies



- special valve body design
- prevents flow noises and provides optimized CV values.
- the "O"-ring gland is replaceable under system pressure.
- the valve cartridge can be replaced without draining the system by means of "Demo-bloc"-tool.

Technical data

Max. working pressure	150 psig (10 bar)
Max. differential pressure	15 psig (1,0 bar)
Max. temperature	250° F (120° C)
Short Term	max. 285° F (140° C)
Low pressure steam	max. 15 psig (1,0 bar) 230° F (110° C)

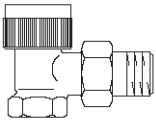
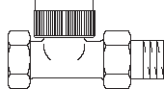
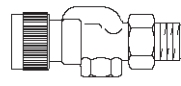
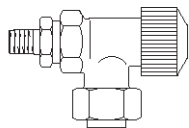
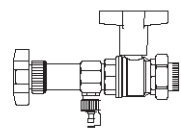
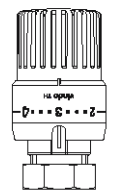
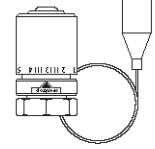
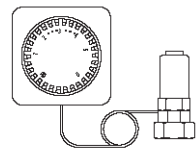
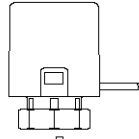

Summary of types and sizes

Type	Size	Item no.	Remarks	
Angle pattern valve	1/2" NPT	2202	with NPT tailpiece and internal NPT thread	
	3/4" NPT	2212		
	1" NPT	2222		
	1 1/4" NPT	2231		
Straight pattern valve	1/2" NPT	2200	with NPT tailpiece and internal NPT thread	
	3/4" NPT	2210		
	1" NPT	2022		
	1 1/4" NPT	2230		
Reversed angle valve	1/2" NPT	2204	with NPT tailpiece and internal NPT thread	
	3/4" NPT	2214		
1-Pipe Steam Valve		2240	1/8" NPT	
"Demo-bloc" for all valves		2350	for replacement of cartridges	
Self-Contained Thermostat		2260	with built-in sensor	
Remote Sensor		2270	6' Capillary	
Remote Sensor Controller		2290	6' Capillary	
Electro-thermal actuator		2280	24 V normally closed	
Replacement Insert		2358	Fits any valve	

Dimensional Data

D	D1	L1	L2	L3	L4	H1	H2	H3
1/2"	1/2"	2-9/32"	1"	2-9/32"	3-3/4"	1-15/16"	1-1/8"	1-9/16"
3/4"	3/4"	2-19/32"	1-1/8"	2-1/2"	4-3/16"	2-1/16"	1-1/8"	1-15/32"
1"	1"	2-31/32"	1-11/32"	3-1/8"	4-15/16"	2-13/32"	1-1/8"	
1-1/4"	1-1/4"	3-3/8"	1-17/32"	3-35/64"	5-29/32"	2-11/16"	1-5/16"	

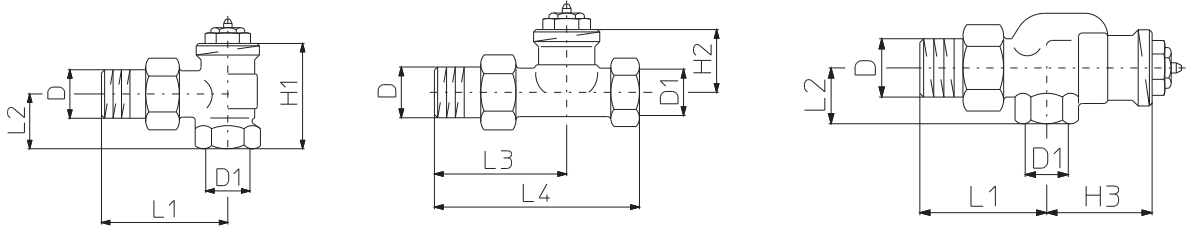

5 Park Lake Road, Sparta, NJ 07871
 973 383 9888 (Phone) 973 383 9088 (Fax)
 Email: sales@istec-corp.com Web: www.istec-corp.com