

DY SERIES VORTEX METER WIRING

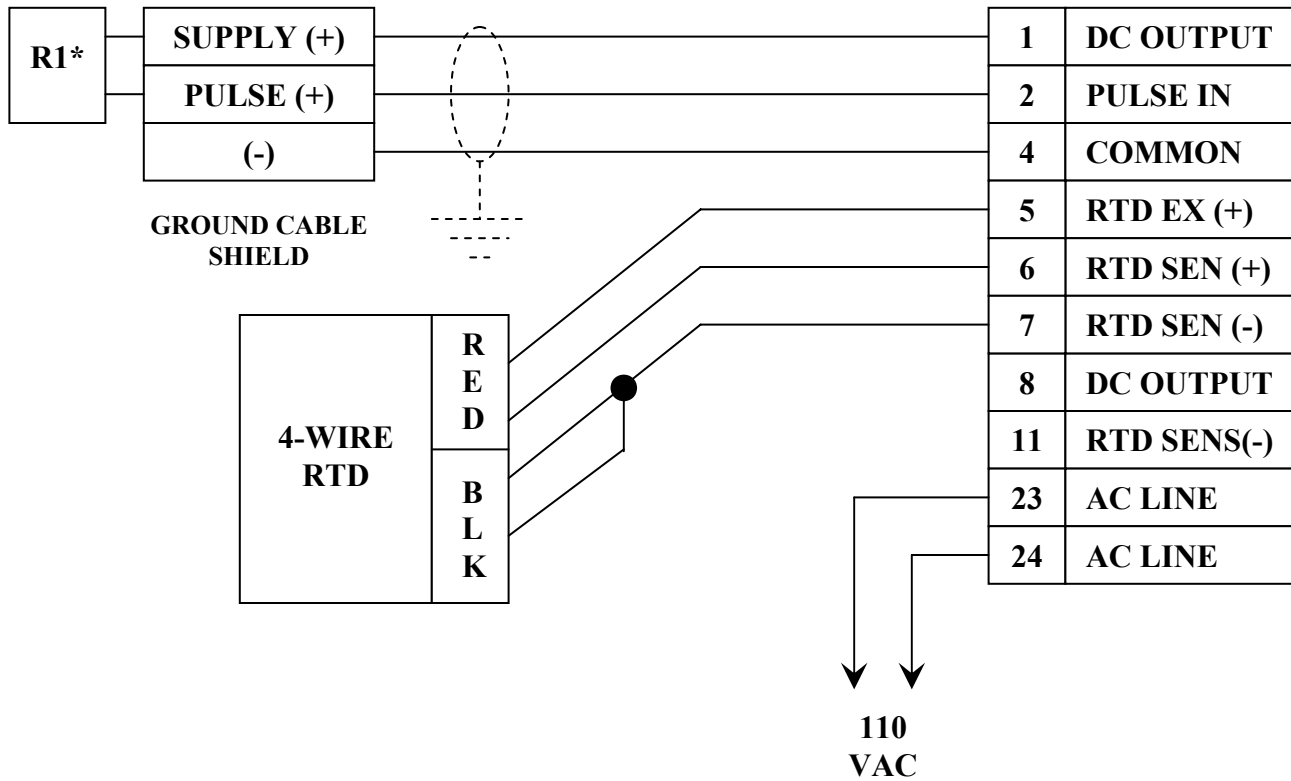

DY SERIES VORTEX FLOW METER

ISTEC 9595 SERIES MASS FLOW COMPUTER



NOTES:

USE 3-WIRE SHIELDED CABLE, BELDON 8770 OR EQUAL.

*A 1.0KΩ/2W RESISTOR (R1) MAY BE REQUIRED. INSTALL ACROSS THE “+” TERMINALS WHEN USING THE PULSE OUTPUT.



5 PARK LAKE ROAD, SPARTA, NJ 07871
 PHONE: (973) 383-9888 FAX: (973) 383-9088 www.istec-corp.com